



Extrusion Equipment

for the Cable Industry

TROESTER

EXCELLENCE IN EXTRUSION.



Innovations

for the Cable Industry

04 Company Profile 06 Extrusion Lines 08 CCV Lines 10 VCV Lines 12 Rubber CV Lines 14 Insulation and Sheathing Lines
16 Extruders 17 Cross Heads 18 Cable Machines 20 Manufacturing and Assembly 22 Line Control/Electrical Equipment
24 Engineering/Project Management 25 Research & Development 26 TROESTER Worldwide



»To achieve the possible, we must constantly attempt
to accomplish the impossible«

Hermann Hesse *(German poet and Nobel prize-winner, 1877-1962)*



EXCELLENCE IN EXTRUSION.



Foundation Year	1892
Managing Directors	Dr. Peter Schmidt (President) Dipl.-Ing. Bernd Pielsticker
Staff	approx. 500 employees in administration, mechanical and electrical design, R&D and manufacturing
Subsidiary Companies	TROESTER Machinery, Ltd./USA TROESTER Machinery (Shanghai) Co., Ltd./PR China X-Compound GmbH, Switzerland Stahl- und Metallbau Rethen GmbH, Germany
Representative Offices	in Russia and France
Representations	in over 40 countries



Excellence in Extrusion

In 1892, the engineer Paul Troester struck upon the innovative idea of building machines which could process unvulcanised rubber and guttapercha. He thus laid the foundation for a name which is world-renowned and synonymous for technological advancement, quality and outstanding performance in the fields of rubber and plastics processing.

The essential feature of all machines and lines build by TROESTER is their superior process technology. Highly qualified development engineers design efficient extrusion lines with a long service life. The latest production processes for the manufacture of cables, tires, automotive and industrial rubber goods require customized system technology. TROESTER develops efficient machine and equipment control systems which flexibly employ the hardware components of leading manufacturers.

TROESTER developments will continue to set the milestones for rubber and plastics processing in the future. In doing so, we are committed to the growing demands for quality, efficiency and environmental compatibility.





Extrusion Lines for Energy Cable Production

Continuous technical further development in collaboration with TROESTER customers from all over the world provides a security for economically working machines and lines that stand out for their excellent product quality.

The excellent results produced by our extrusion technology, combined with optimal control and regulation systems, have turned TROESTER into a competent manufacturer of complete lines and individual machines in the cable industry. Extensive know-how means flexibility for customers. The spectrum ranges from re-fitting or changing existing lines with TROESTER machines all the way to implementing new cable system technologies, e.g.:

- > **CCV lines for MV, HV, EHV cables**
- > **VCV lines for HV and EHV cables**
- > **Rubber CV lines for LV and MV Cables**
- > **Sheathing lines for LV, MV and HV Cables**
- > **Core insulation and sheathing lines**

For the insulation and sheathing of high voltage power cables, submarine cables, mining cables, automotive wire, building wire, and further sophisticated utilization for energy cables there is no one in business who reaches the claim of TROESTER: Excellence in Extrusion.



EXCELLENCE IN EXTRUSION.



CCV Lines for the Production of MV, HV and EHV Cables

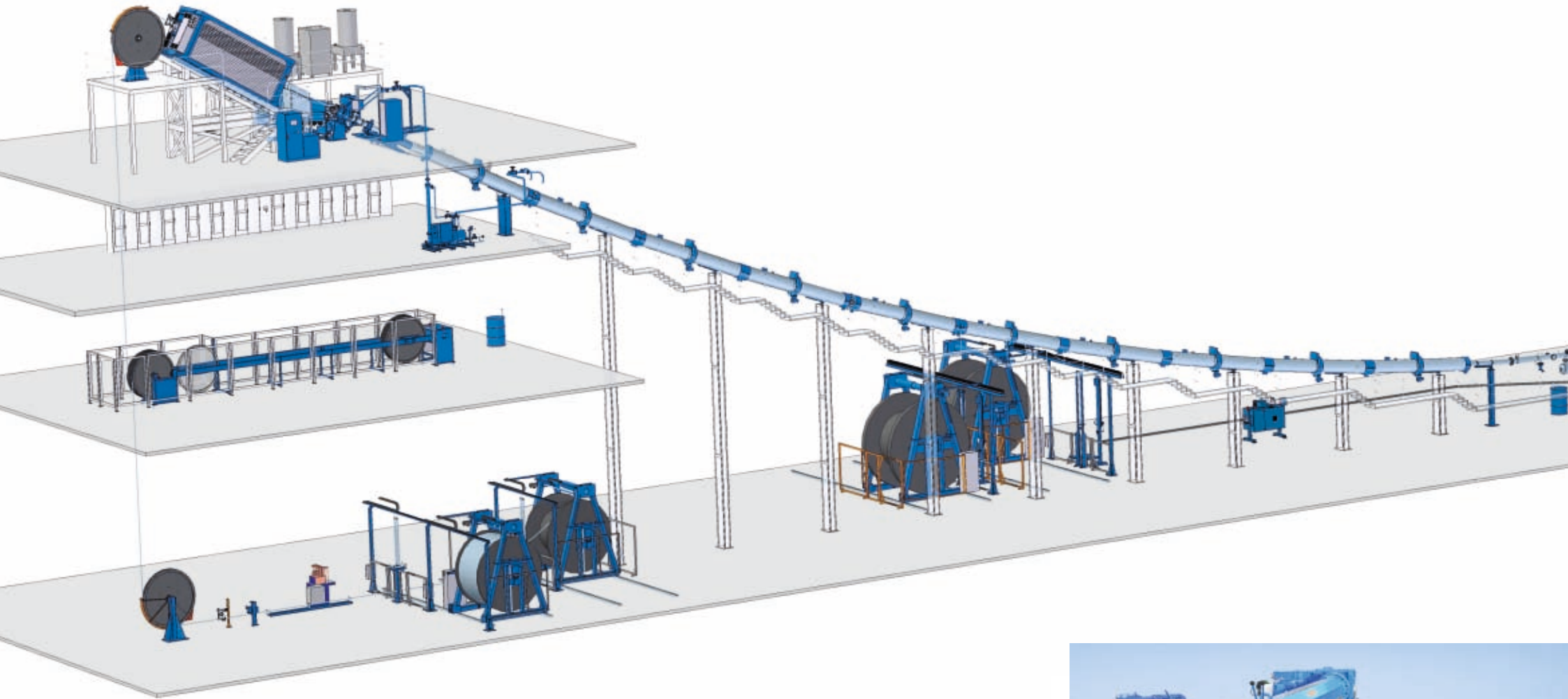

Extrusion Group
Rotating Caterpillar RAGG
Double End Seal
Troester ROUNdness Stabilizing System TROSS



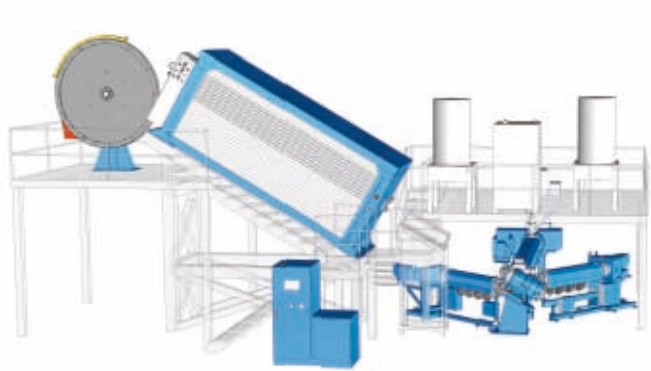

- > Cost effective production of MV, HV and EHV cables on one line
- > Perfect concentricity and roundness through TWINROT and TROSS
- > Use of standard insulation compounds
- > Long production lengths
- > High output concepts

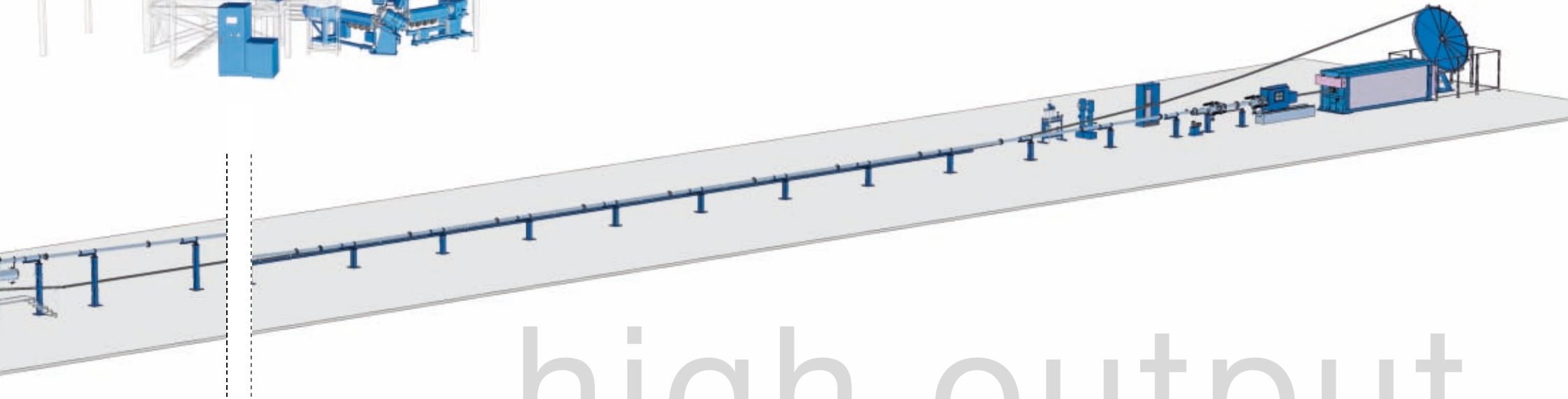

high output



VCV Lines for the Production of HV and EHV Cables

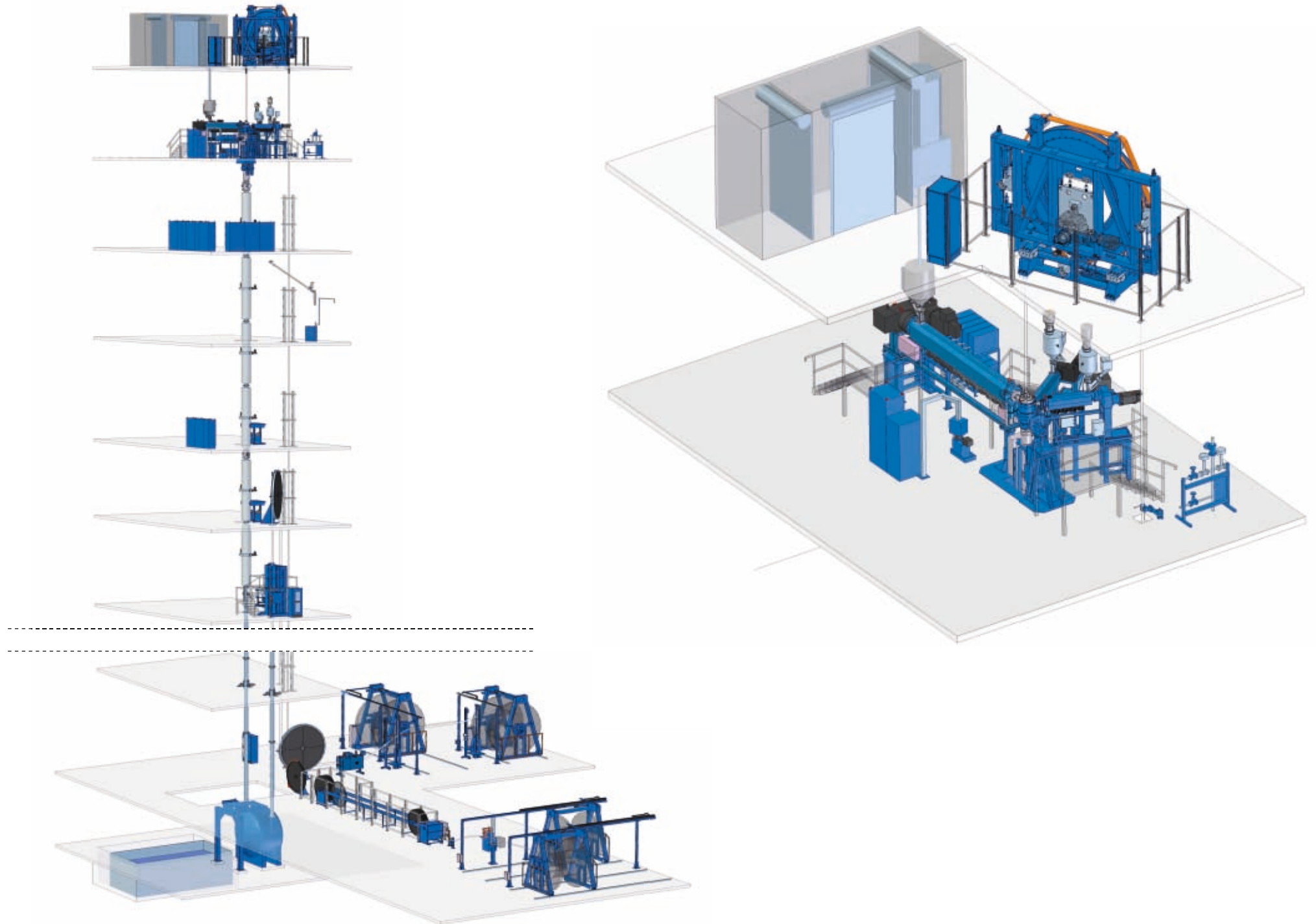

- > Excellent core tolerances for HV / EHV cables
- > Superior process technology
- > Preheating and postheating
- > Long and stable production runs
- > Innovative line concepts: L-type, U-type, V-type

Triple Cross Head TQU
Turn Around Pressure Vessel
Capstan CA
VCV Tower

innovation

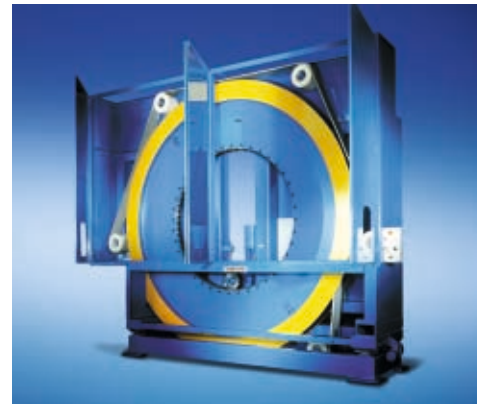

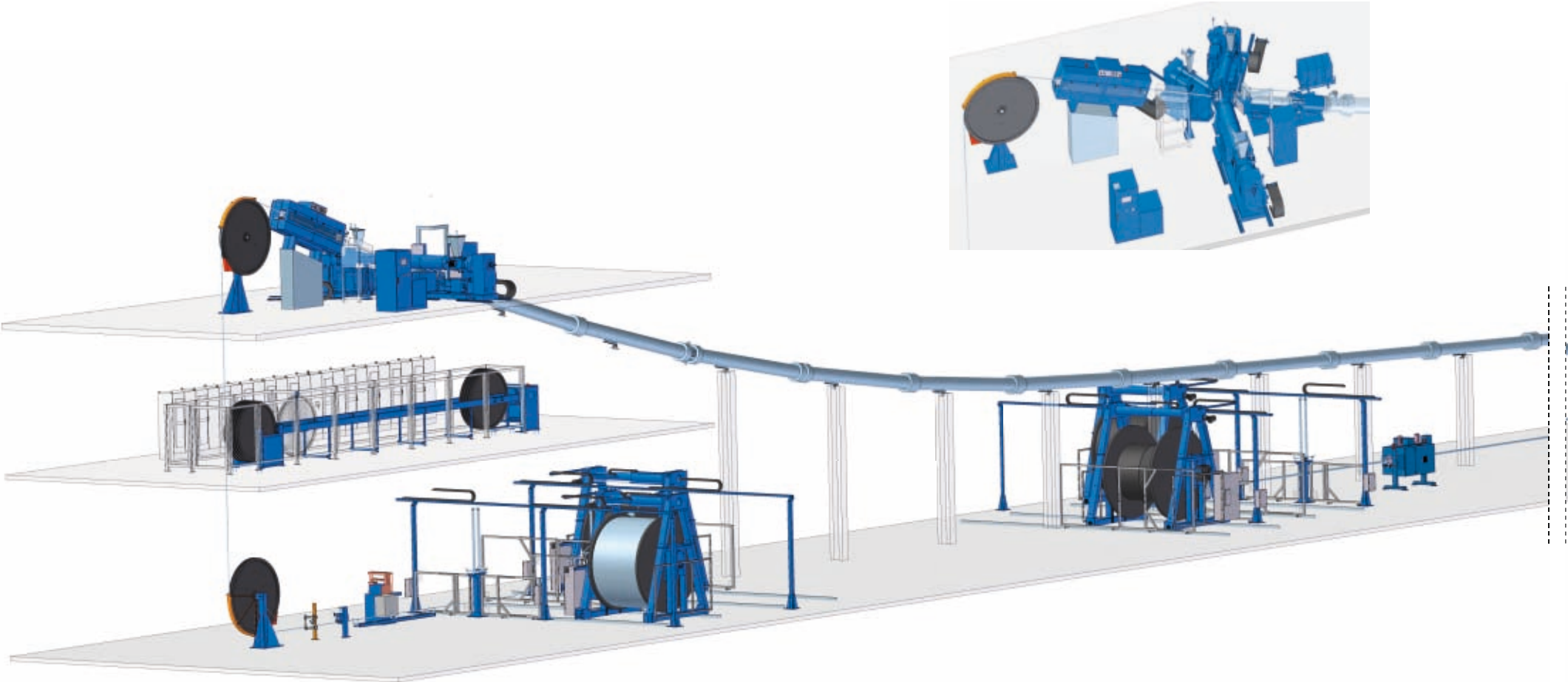

- Extrusion Group
- Feed roll in Hopper section
- Embossing Unit
- Belt-type Caterpillar AG
- Portal Winder AWB



- > 1- and 2-layer rubber insulation and sheathing
- > Medium Voltage (35 kV) triple extrusion process
- > Flexible production modes for a wide product range
- > Combined Rubber- and XLPE-Extrusion lines
- > Over 120 years of experience in rubber processing technology

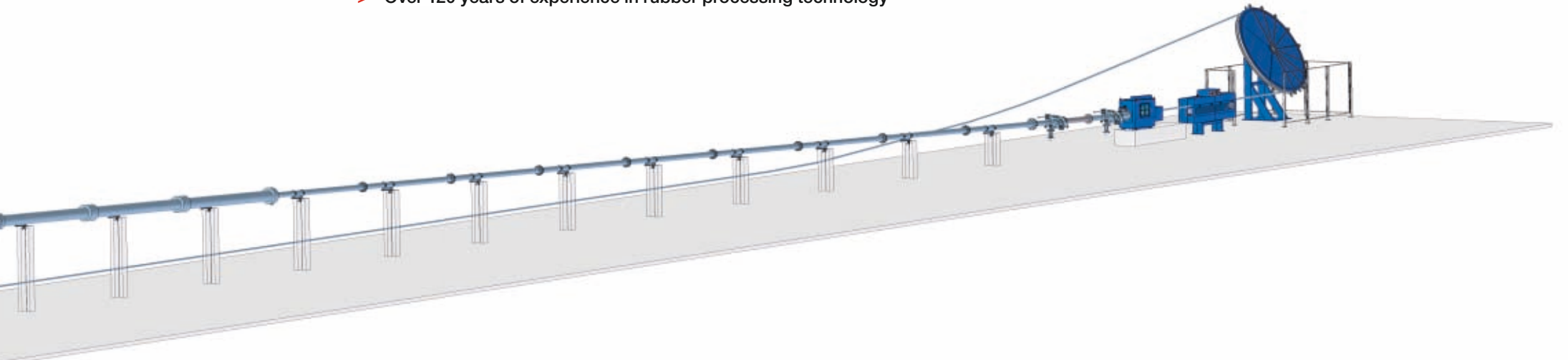

flexibility



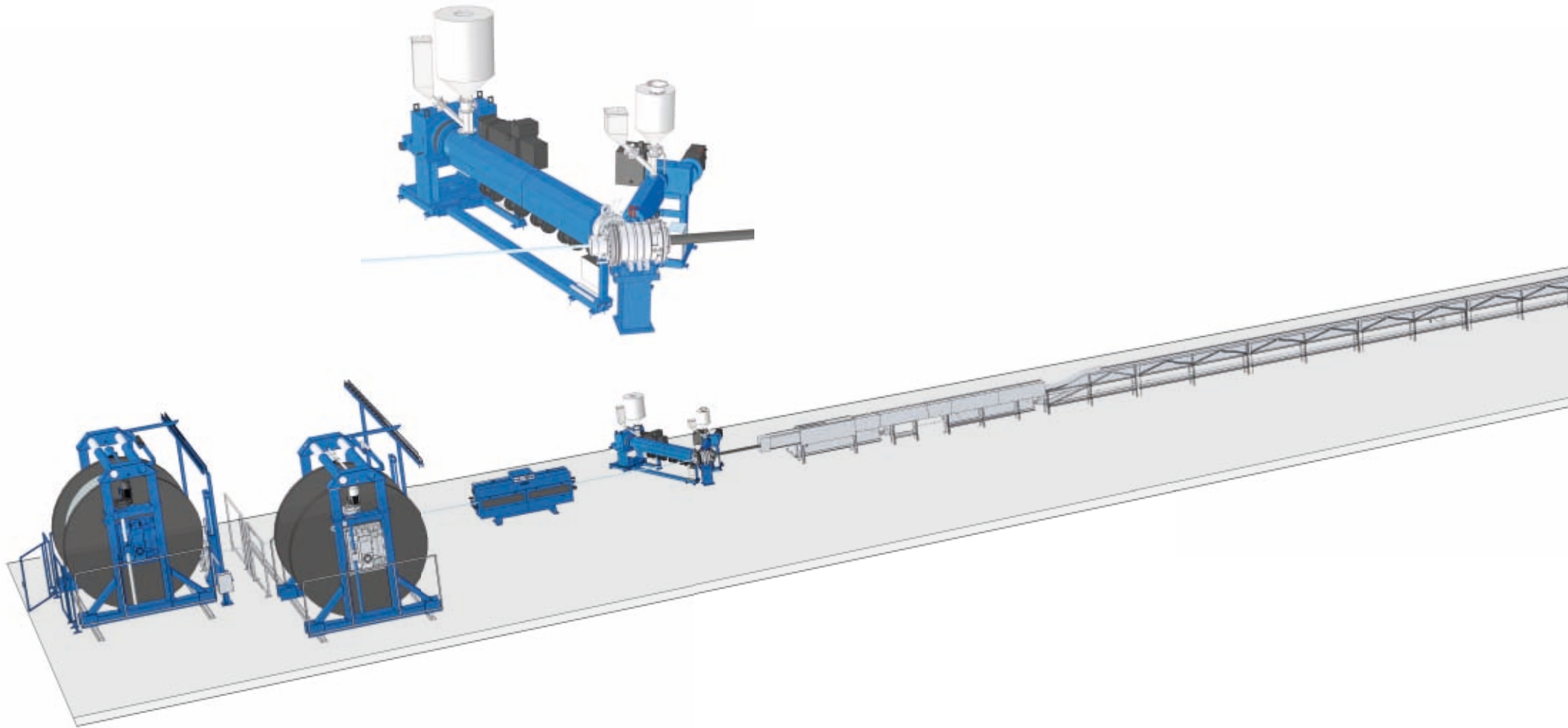

Extrusion Group
Belt-type Caterpillar AGP
Cooling Through
Portal Winder TABA/TAFA



- > Automotive and building wire extrusion
- > MV/HV sheathing lines
- > Efficient production over wide product range
- > Optimized cooling process for best surface quality
- > Heavy duty machinery for cables up to 100 kg/m

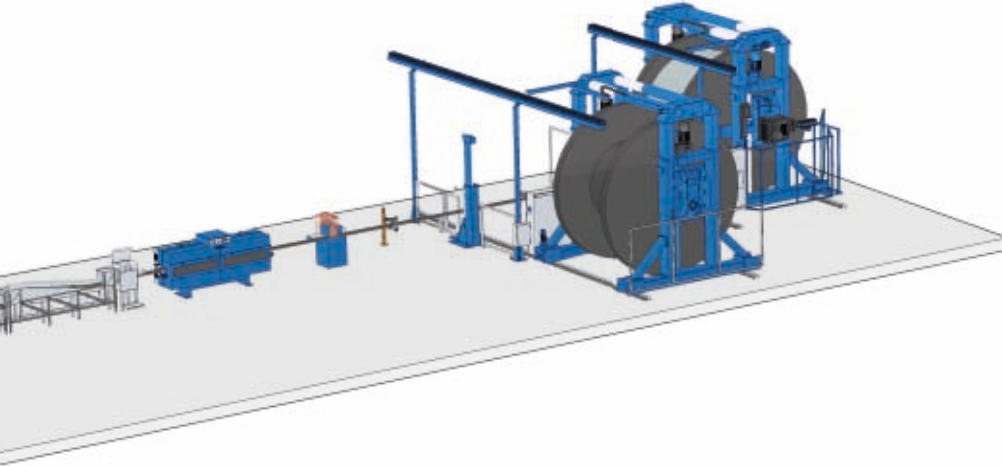

efficiency



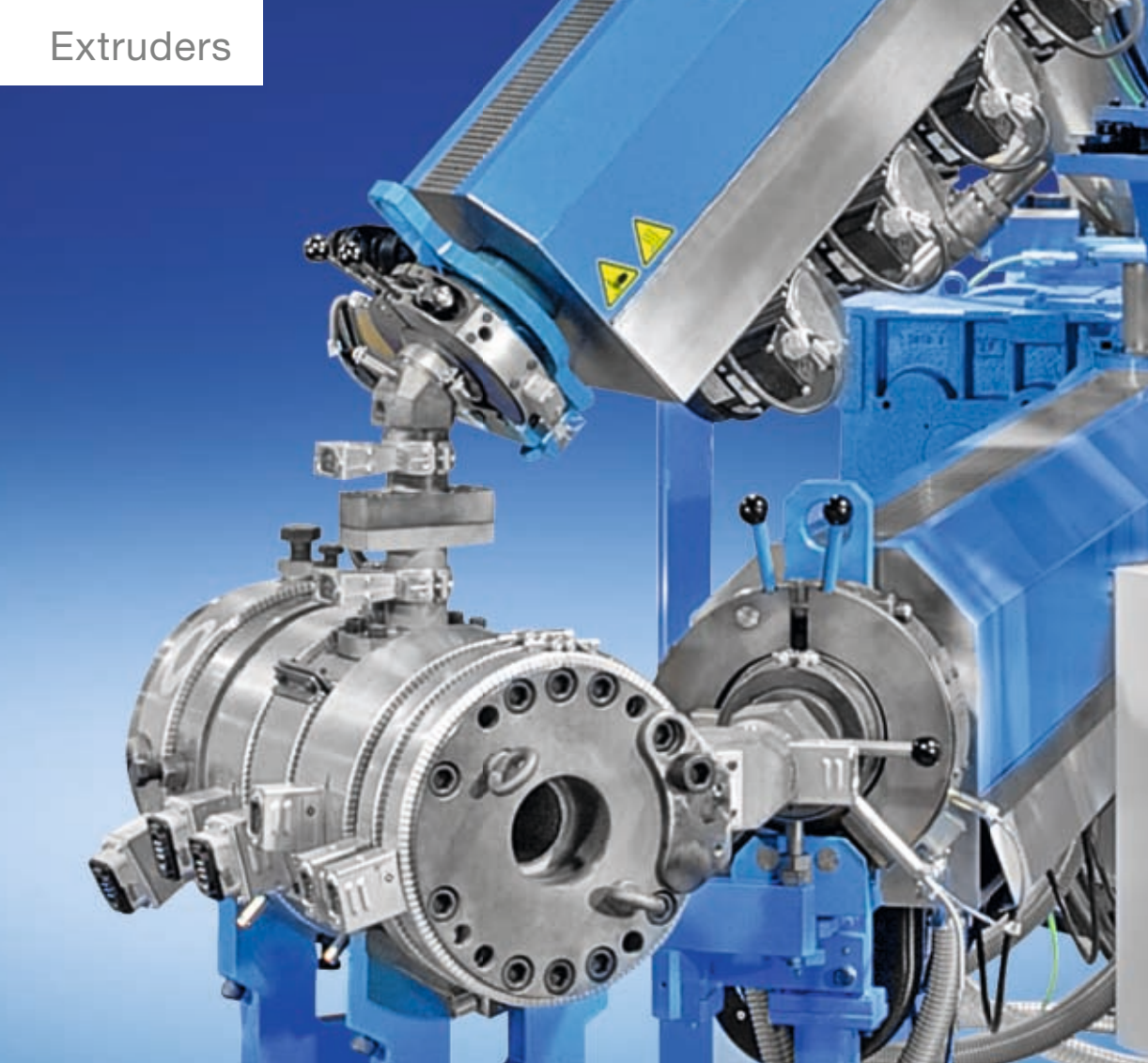

Extruders

TROESTER extruders for the processing of plastic or rubber compounds play an important part in the cable industry, worldwide.

The extruders are used to provide the insulation and sheathing of electrical cores, conductors and cables; either as a single extruder or an extruder group, depending on the task in hand. Around 80 years of experience in the development and construction of screw extruders underpin the design and processing concept on which TROESTER extruders are built.

The extruders are designed according to the latest developments in process technology. Continuous improvements and comprehensive testing in the TROESTER R & D department in conjunction with computer simulations provide the basis for an optimal extruder- and screw-design. This optimization process is further aided by the wide-ranging extrusion tests and trials carried out in cooperation with compound manufacturers.

Extruder control is via a modular automation system. This is assembled in line with the requirement profile and controls, regulates and optimises the extruder as a single unit or as part of a combined system.

- > **Suited to a wide range of applications**
- > **High throughput values with the retention of excellent linearity**
- > **Stable melt temperature**
- > **In-house screw development and production**
- > **Low-maintenance design for an extended service life**

Cross Heads

TROESTER specializes in single, double and triple layer extrusion. It develops and makes extrusion heads for all types of lines (e.g. core insulation, sheathing, silane, silicone and rubber CV lines). Many different types of product can be made with just one single head.

The flow channels of all TROESTER extrusion heads are extremely precisely manufactured and the wall-thickness tolerances correspondingly tight. High-quality products, made with a minimum of materials, are the result. Therefore, TROESTER supports all cable manufacturers' demands for top levels of production efficiency. Computer-optimized material flow channels also play an important role.

Excellent efficiency is what all TROESTER extrusion heads have in common. They also stand apart for their very short heating-up periods. Electrical heating and liquid temperature control, using heating / cooling units, keep the head temperatures stable. Quick-change clamps keep set-up times to a minimum. The head is easy to clean which also saves time.

TROESTER extrusion heads offer excellent flexibility in production planning processes.

- > Long life and low maintenance design
- > Large product range on each cross head
- > Computer calculated distribution flow channels
- > Low tolerances for material saving operation
- > Short tool changing times





Cable Machines from One Source

The planning, design and construction of cable production lines requires one thing above all else: experience of exactly what equipment should be selected! This will determine the type of process employed and the necessary technical components.





TROESTER GmbH & Co. KG is a supplier of complete cable production lines as well as individual cable machines, such as Winders, Accumulators, Caterpillars, Capstans in various sizes and designs. Apart from standard machinery, highly skilled engineers work out solutions to meet customer-specific requirements to obtain technically optimized processes

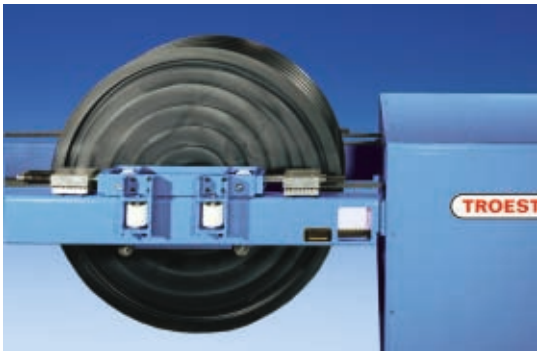

Manufacturing and Assembly

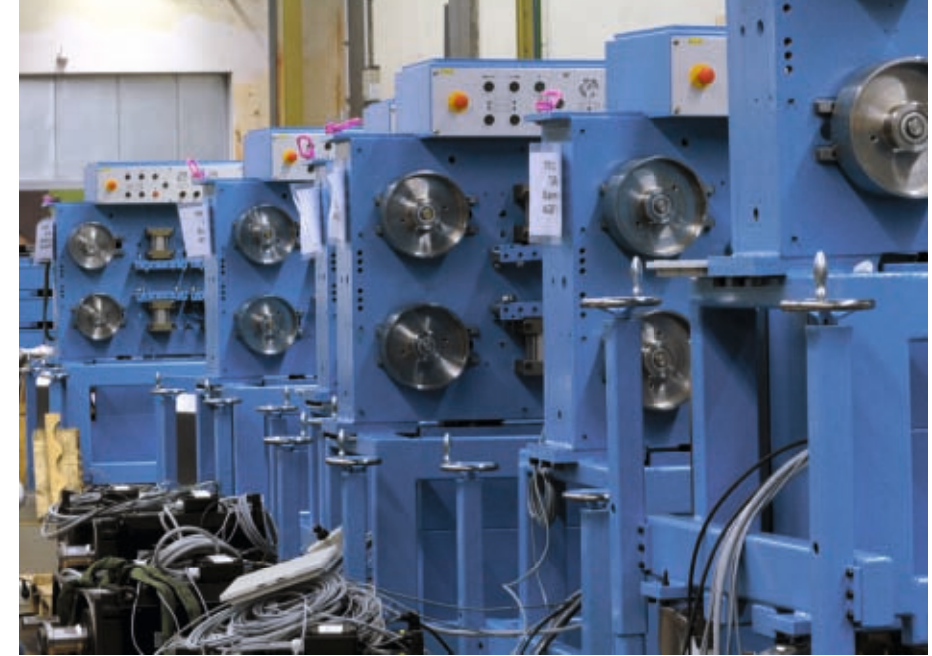

Manufacturing and Assembly

Customers have come to expect a high degree of quality from TROESTER because the true efficiency of machinery only becomes apparent during a long product life cycle. To meet these expectations TROESTER places huge emphasis on in-house manufacturing. In the past few years, the level of in-house manufacturing of TROESTER machinery has steadily increased. Insourcing instead of outsourcing is the roadmap pursued.

The cornerstones for increasing production and enhancing product quality were substantial investment in TROESTER's machinery, CNC-driven production processes and stepping up training of all personnel.





The drive to manufacture products made in Germany has given an enormous boost to TROESTER employees' identification with the company. TROESTER's well-trained personnel works in three shifts and takes its responsibility towards customers very seriously. As a result, personal store is set by checking the quality of machinery made in-house.

- > Screw milling
- > Hard-facing of screws
- > CNC controlled machining
- > Certified Pressure Vessel production
- > CV tube welding



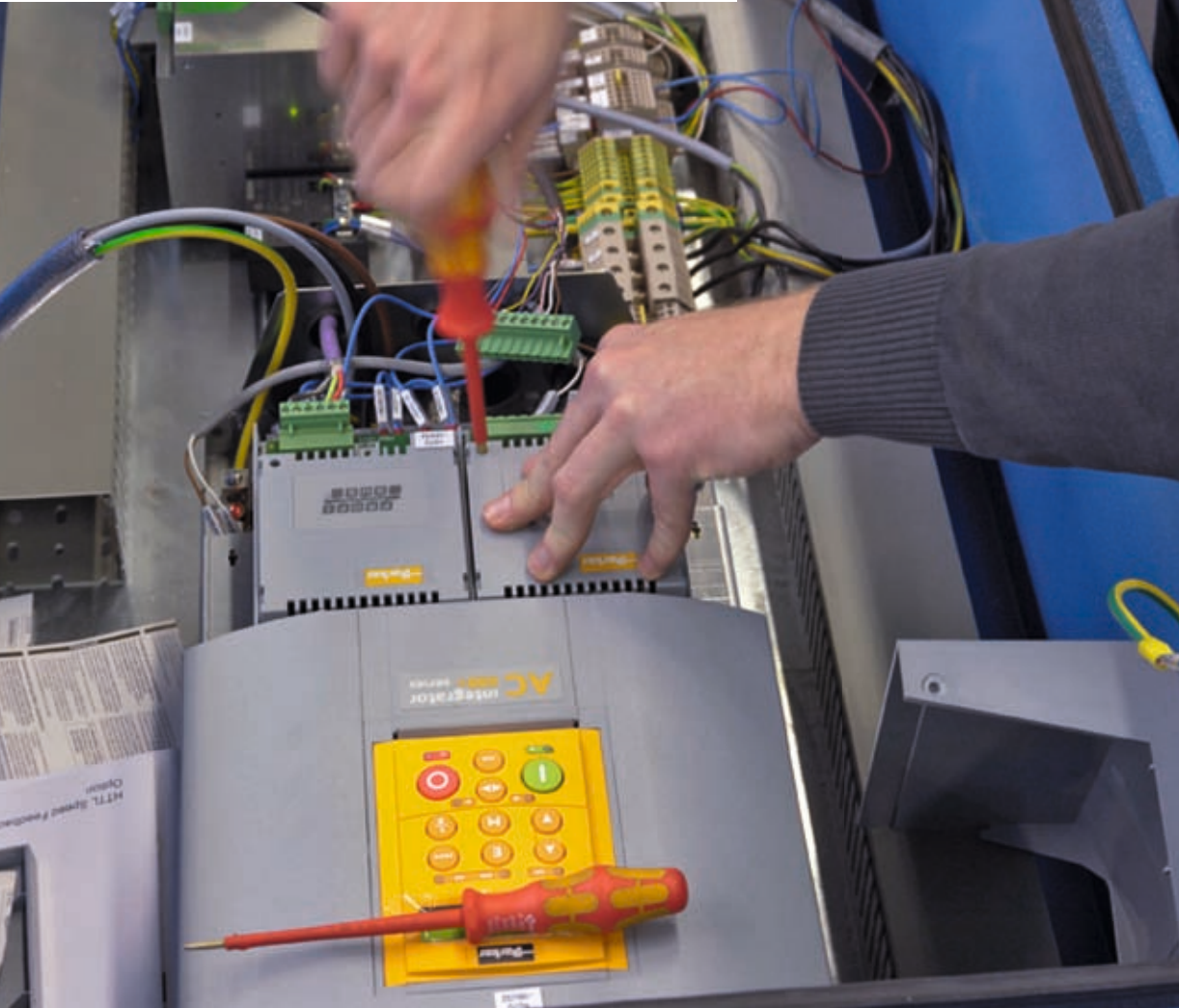

Electrical Equipment and Line Control – Solutions from One Source

The extrusion line control systems as well as the design of electrical components are significant elements of TROESTER's equipment portfolio. The extrusion unit works with the downstream equipment as a functional unit enabling constant product dimensions in the various production stages. The control is developed, designed and programmed in-house by using the latest available electrical components. Customer specifications and preferred sub-suppliers are considered according to the individual needs of the cable manufacturer.

Typically the line control consists of a PLC-PC architecture. In the field area all electrical units like drives, sensors, measuring equipment, identification and marking systems are controlled by the PLC. For many years the most well-known field bus systems (Profibus, Profinet, DeviceNet), with distributed I/O stations are used. The advantage is i.e. reduced cabling on customers site and more efficient checking of machine groups before delivery.

Wherever possible all controls (Temperatures, Pressures, Positions) are realized with PLC software, so proprietary discrete controllers with all disadvantages of parameter sets, lack of spare parts are unnecessary.

The Line-PC is used for visualization and process trending, recipe handling and the long-term production and quality protocol. For each production run the production parameters as well as the quality results will be stored. Such production results are summed up in statistically measured parameters. Besides having long-term information about the production history, the data can also be used for labeling / identifying the manufactured goods.



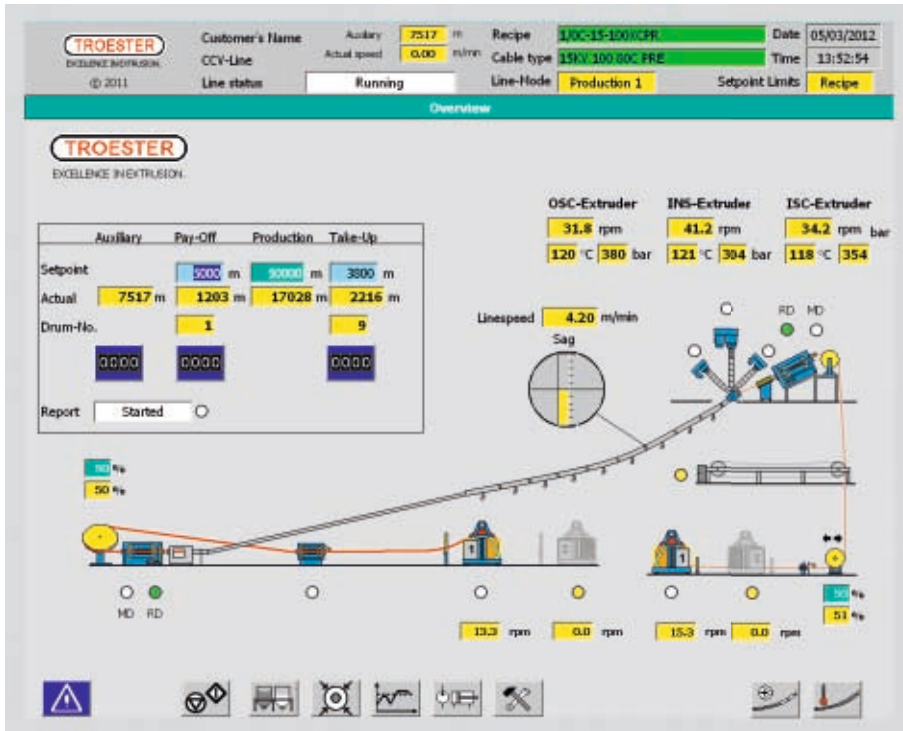

There is a tendency towards connecting the Line-PC to the plant network to receive the pre-selected daily production schedule of the line from a host and to provide the production data automatically from the line via network to a plant server. State of the art is a configuration with the PC as a redundant system to ensure that quality documentation and production reports are provided without any lag.

The Ethernet concept to connect all PLCs and SCADA-PCs in a cable production line supports teleservice up to each endconnected unit. This way TROESTER engineers can support the operators on site in real-time from the Headquarter in Hannover, Germany. Ethernet supports the tendency of merging the company network together with the entire line control.



Management for your Success

Individual projects require individual support as well as the development of distinct technical skills. To achieve all of the customers project goals, TROESTER has an outstanding project management.

The project manager is the customers' link to technical and commercial departments. He is responsible for scheduling the entire project internally and externally, date monitoring, cost management and all other project relevant objectives.

He has broad engineering know-how and can give quick assistance during the entire planning phase as well as after the machines have been installed and commissioned.



Innovations for the Cable Industry

The R&D process engineers design all the components in the cable machinery that are important from a process engineering point of view. Essential factors are the high-quality demands customers make of the products and efficiency of the machinery during operation.

Flow channels for the melt, e.g. the distributors in the extrusion heads with up to three melt layers, are simulated and optimized using Finite Element analyses. The goal is to keep the pressure gradient as low, the melt distribution as even and the material retention time in the heated zones as short as possible.

Using simulation software and mathematical models, the extrusion screws are designed for high output at low melt temperatures following the requirements of the processed materials.

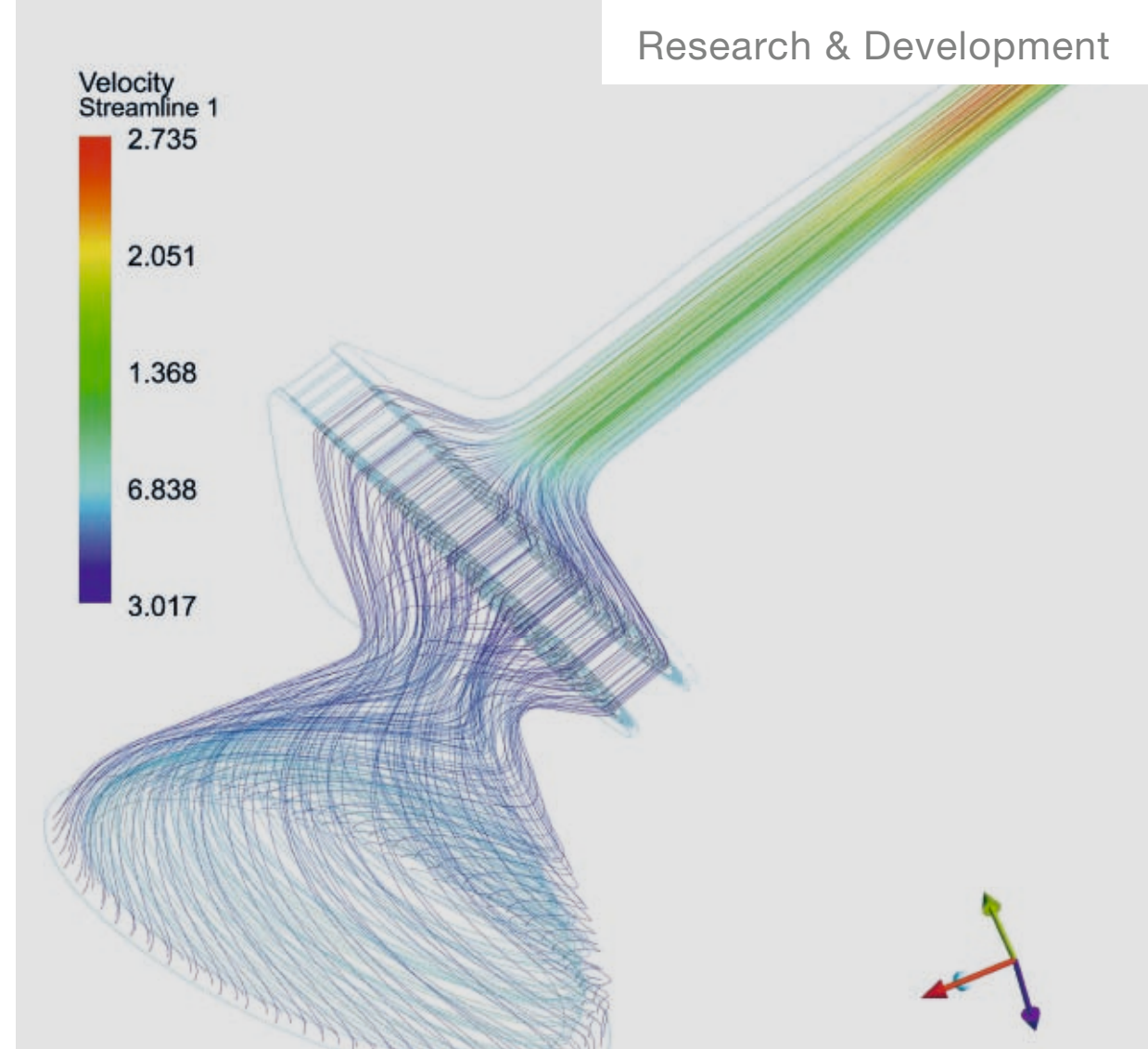

The vulcanization and cooling phases are simulated using in-company developed software. This way required zone lengths that fit each of the process steps best can be established for the customer's product range.

The R&D's technical lab is equipped with extruders in different sizes. The designs of screws and heads are tested here under real-world conditions in close cooperation with all well-known material suppliers.



TROESTER GmbH & Co. KG, Germany



TROESTER Machinery Ltd., USA
TROESTER Machinery (Shanghai) Co., Ltd.
X-Compound GmbH, Switzerland





TROESTER GmbH & Co. KG
Am Brabrinke 1-4
30519 Hannover, GERMANY
Phone +49-511-87040
Fax +49-511-864028
E-mail innovations@troester.de
www.troester.de

TROESTER Machinery, Ltd.
300 Loomis Avenue
Cuyahoga Falls, Ohio 44221, USA
Phone +1-330-928-7790
Fax +1-330-928-7239
E-mail info@troester-usa.com
www.troester-usa.com

**TROESTER Machinery
(Shanghai) Co., Ltd.**
Workshop No. 1, Area C
No. 6999 Chuan'sha Road, Pudong
Shanghai 201202, PR CHINA
Phone +86-21-58598308
Fax +86-21-58598310
E-mail info@troester.cn
www.troester.cn

TROESTER Moscow
Moscow, 109815, RUSSIA
Phone +7-495-7601423
E-mail lusia13710@mail.ru

X-Compound GmbH
Hardmatt 932
CH -5082 Kaisten, Switzerland
Phone +41-62-869 10 30
Fax +41-62-874 32 08
E-mail info@x-compound.com
www.x-compound.com

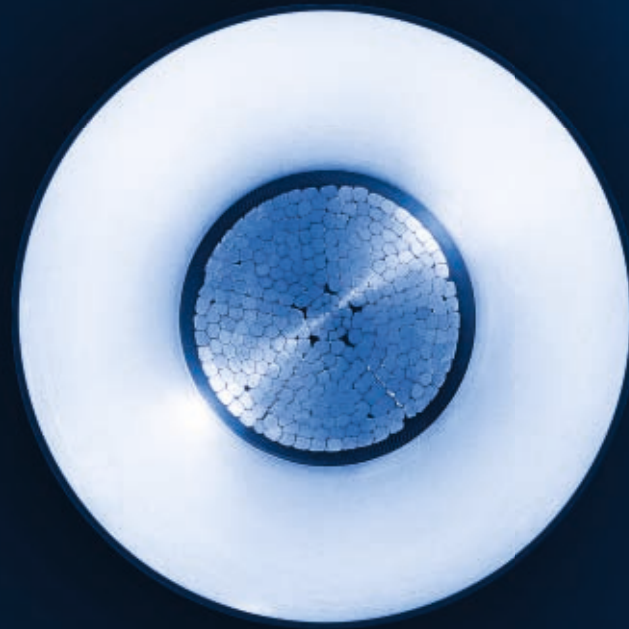

www.troester.de