





VMI - AZ Extrusion GmbH

Bahnhofstr. 6 · 93486 Runding · Germany

☎ +49 - 9971 - 76139 - 0 · 📠 +49 - 9971 - 76139 - 250

Info@vml-az.com

US - Office

4485 Allen Road · Stow, OH 44224-1042 · USA

☎ +1 - 330 - 929 - 0815 · 📠 +1 - 330 - 929 - 3073

www.vml-az.com





VMI - AZ EXTRUSION GMBH



EXTRUDER MCTD



EXTRUDER / GEARPUMP SHARK®

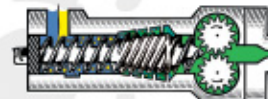

EXTRUDER / GEARPUMP COMBEX

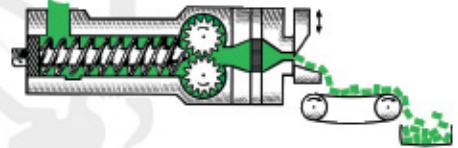

PLANETRUDER®

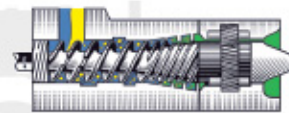

EXTRUSION HEADS



PRE-CURE RETREADING

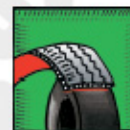

MOLD CURE RETREADING



PATENTS: MCTD extruders, adjustable extrusion heads, cushion-to-casing systems (GTC) and planetruder . . .



COPYRIGHT © 2005 VMI-AZ Extrusion GmbH

We do not give permission for any contents herein to be reproduced in whole or in part in any publication for whatever purpose.



VMI - AZ EXTRUSION GMBH

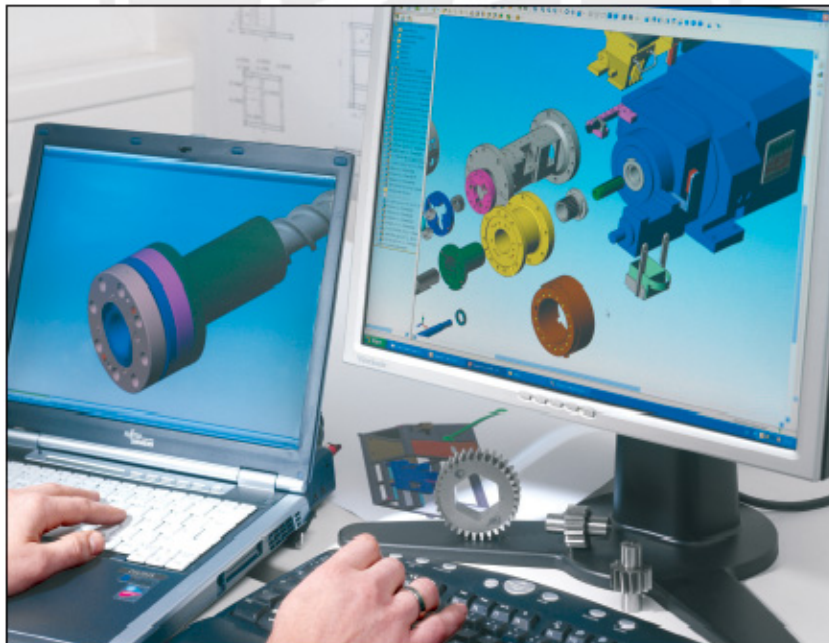

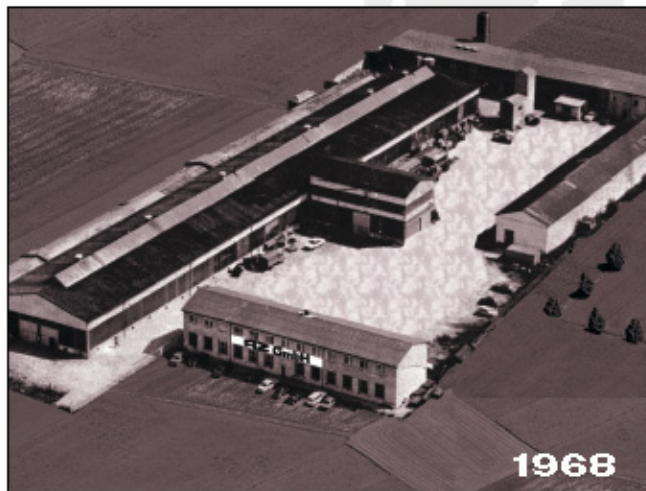

VMI - AZ EXTRUSION GMBH

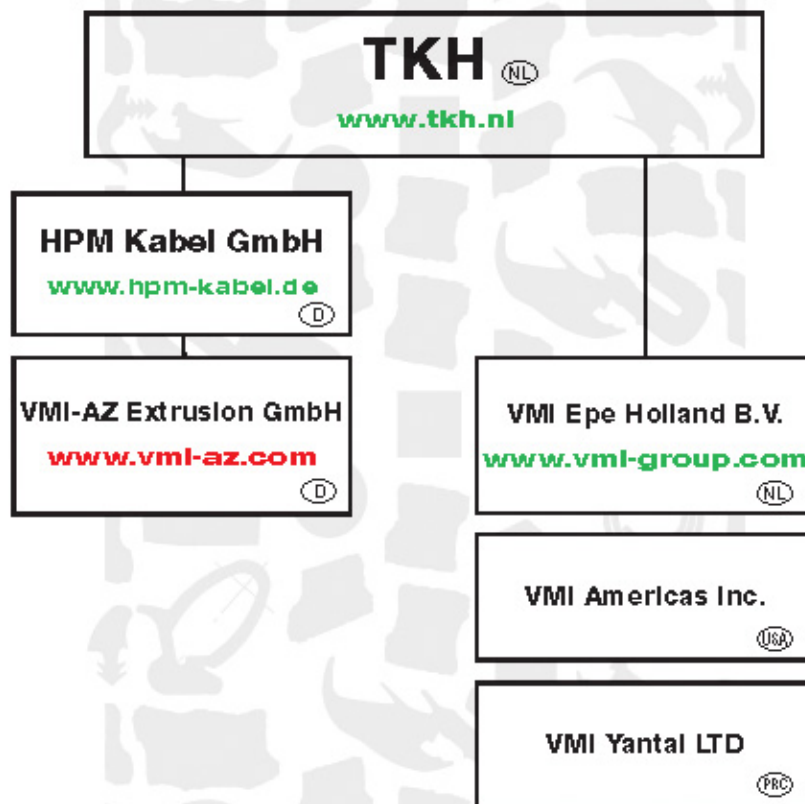

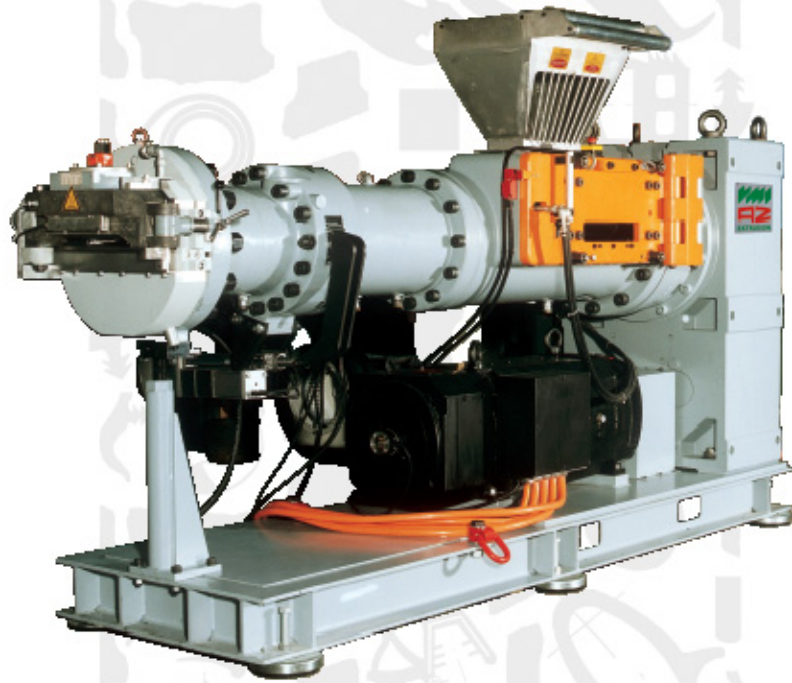
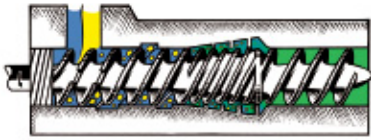

COLD FEED EXTRUDER MCTD

40 kg/h	≤	\dot{m}	≤	7800 kg/h
10	≤	L/D	≤	18
25 mm	≤	D	≤	250 mm
		p	≤	300 bar

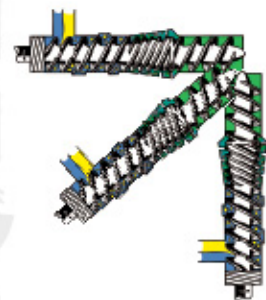
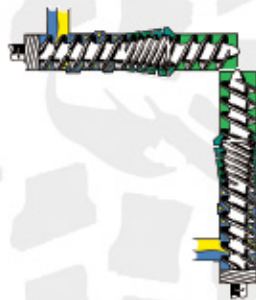

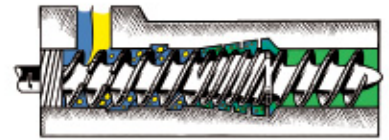

COLD FEED VACUUM EXTRUDER MCTD

40 kg/h	≤	\dot{m}	≤	1500 kg/h
10	≤	L/D	≤	18
25 mm	≤	D	≤	150 mm
		p	≤	300 bar

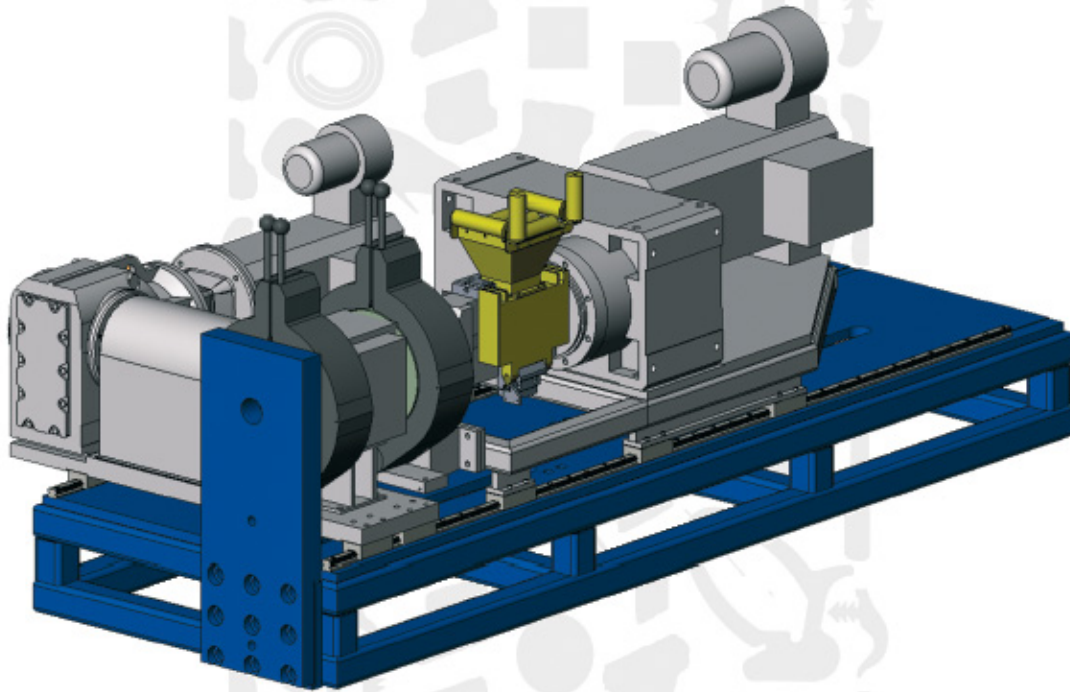
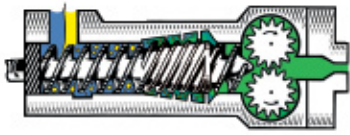

EXTRUDER - GEARPUMP SHARK[®]

40 kg/h $\leq \dot{m} \leq$ 4000 kg/h

4 $\leq L/D \leq$ 10

25 mm $\leq D \leq$ 200 mm

$p \leq$ 500 bar



EXTRUDER - GEARPUMP SHARK[®]



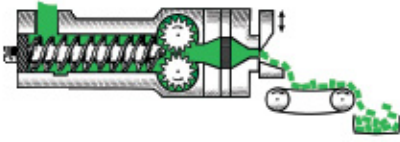

EXTRUDER - GEARPUMP COMBEX

40 kg/h \leq \dot{m} \leq 2500 kg/h
4 \leq L/D \leq 10
45 mm \leq D \leq 150 mm
p \leq 350 bar

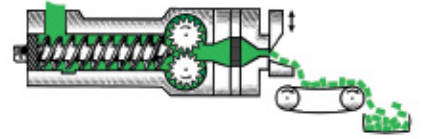

EXTRUDER - GEARPUMP COMBEX

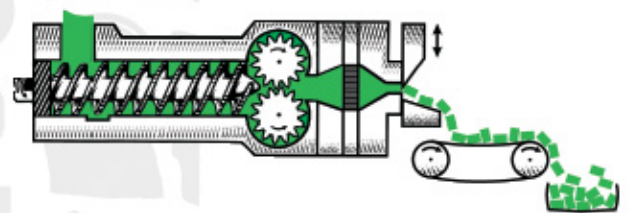

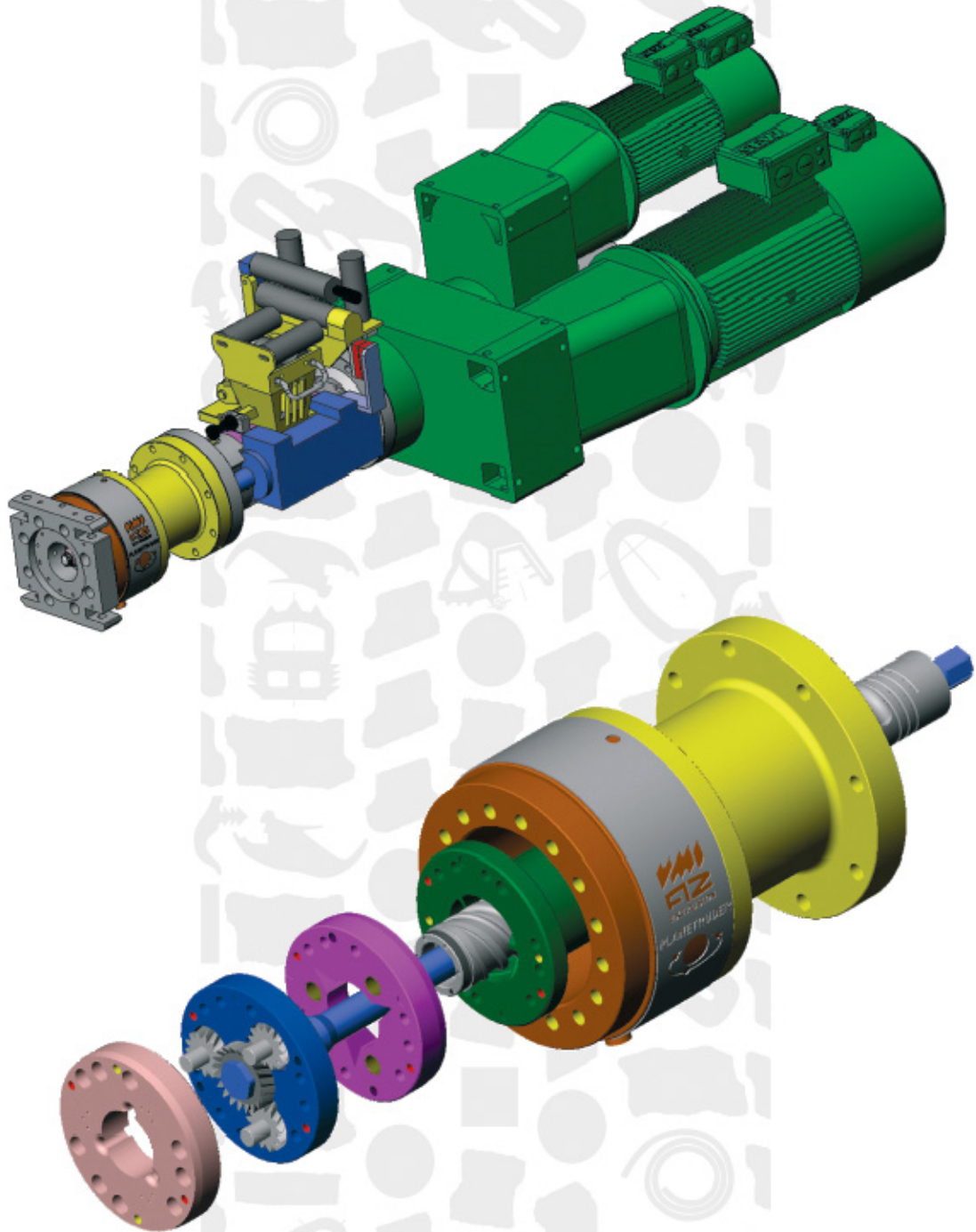
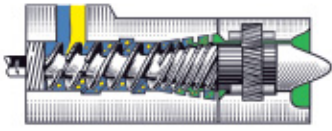

PLANETRUDER®

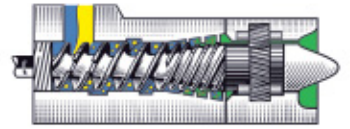

PLANETRUDER®

40 kg/h	≤	\dot{m}	≤	7800 kg/h
4	≤	L/D	≤	12
25 mm	≤	D	≤	200 mm
		p	≤	500 bar

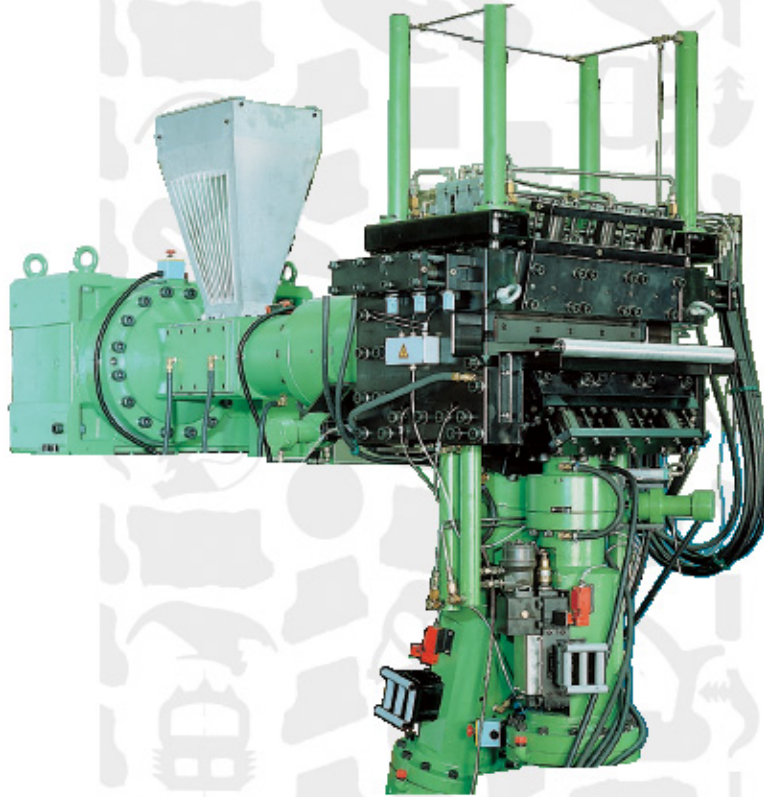
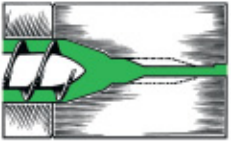

MULTIPLEX EXTRUSION HEADS



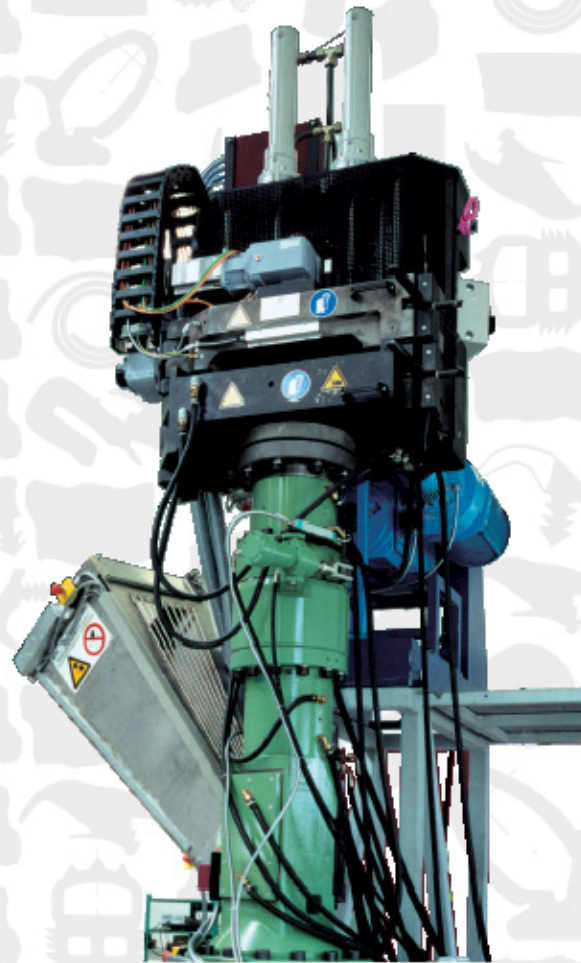
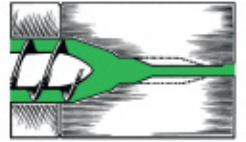

ADJUSTABLE EXTRUSION HEADS

100 mm \leq W \leq 500 mm

O \leq T \leq 30 mm



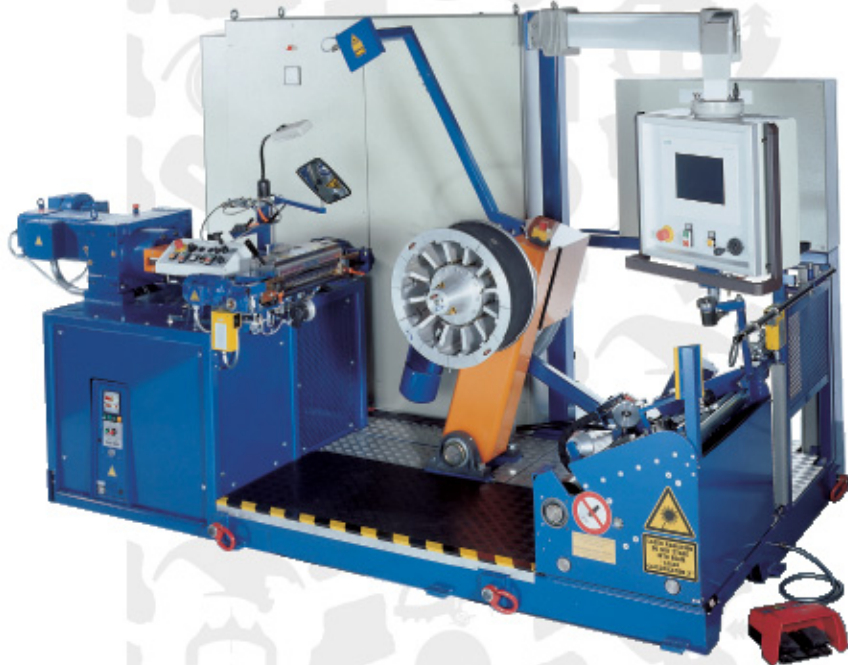

PRE-CURE RETREADING

50  / 8 h - 160  / 8 h



QS





PRE-CURE RETREADING

50  / 8 h - 140  / 8 h



QS



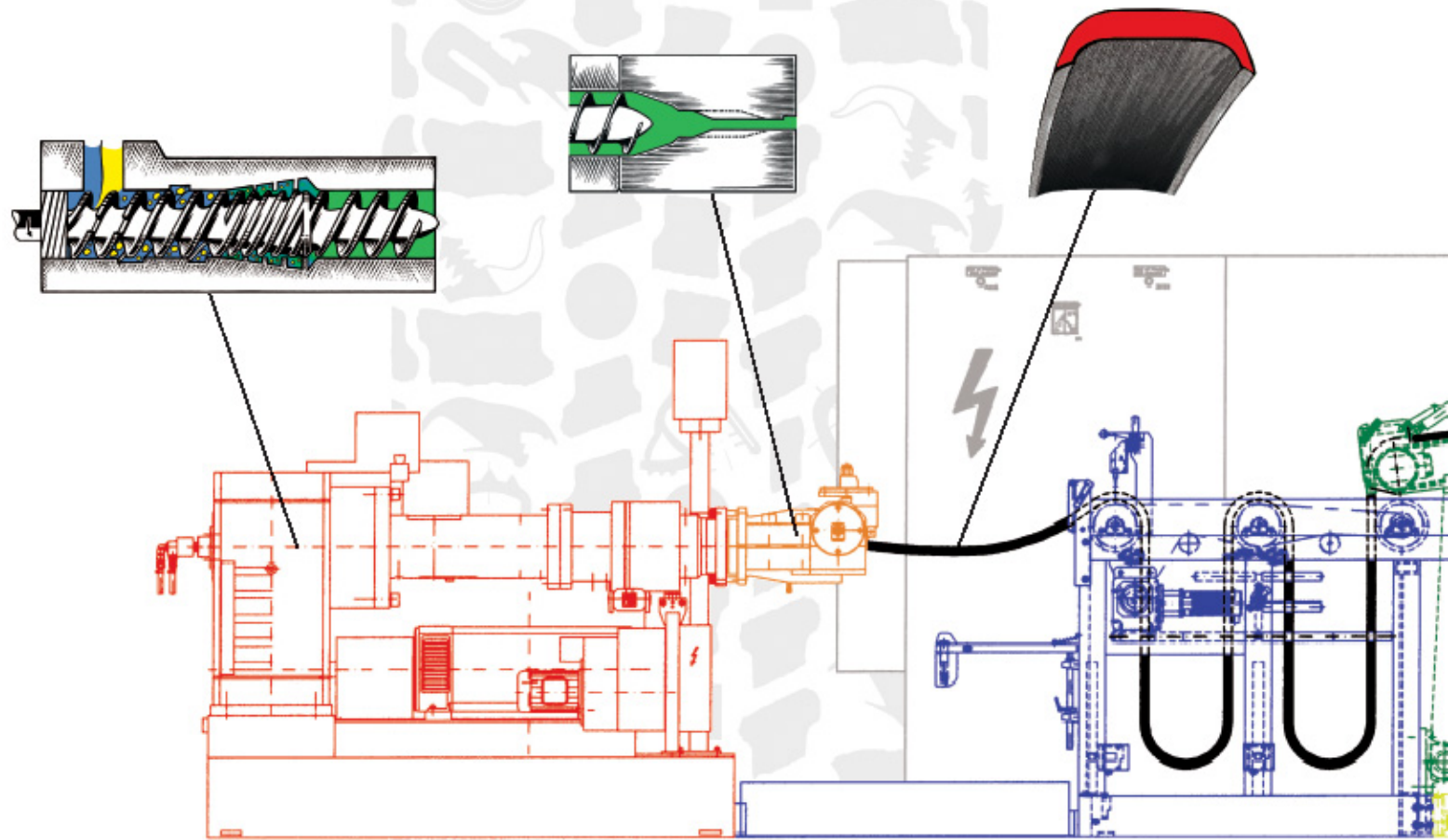

MOLD-CURE RETREADING

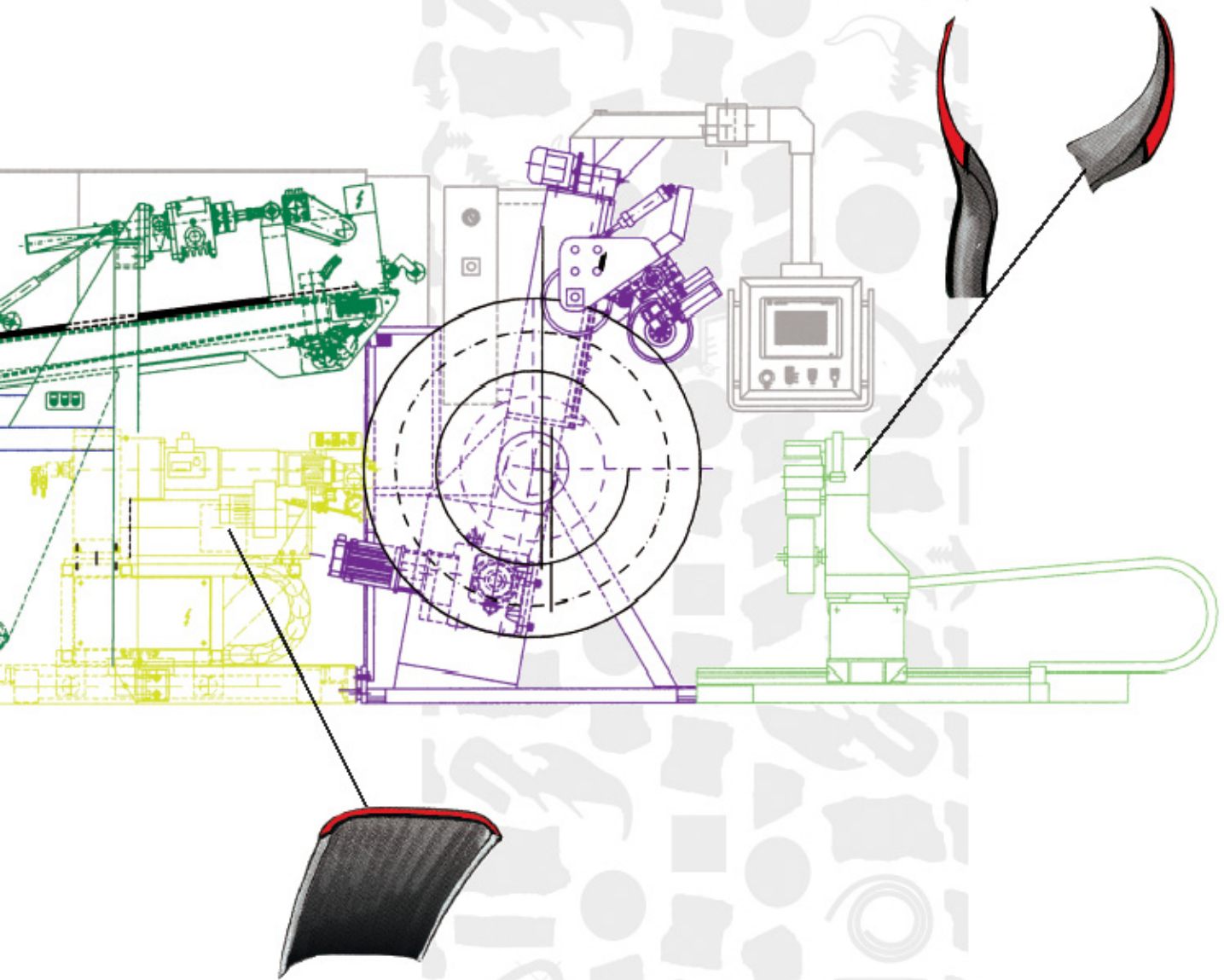



VMI - AZ Extrusion GmbH

Bahnhofstr. 6 · 93486 Runding · Germany

☎ +49 - 9971 - 76139 - 0 · 📠 +49 - 9971 - 76139 - 250

Info@vml-az.com

www.vml-az.com